

A cura di Luciano Ledda Fele



# GENEALOGIA LEDDA

Discendenti di  
Giuseppe Luigi LEDDA e Giovanna Onida  
e Ramo Corsi-Carta



Aggiornamento - 2020





## COME LEGGERE I DIAGRAMMI GENEALOGICI

Ogni diagramma rappresenta una famiglia.

Ogni famiglia è individuata con un numero in riquadro verde.

La rappresentazione è del tipo diagramma ad albero. Ogni discendente è legato ai genitori con una linea.

L'albero può essere rappresentato sia in verticale che in orizzontale, secondo gli spazi disponibili nella pagina

I riquadri azzurri rappresentano il discendente (diretto) maschio, mentre quelli rosa rappresentano il discendente femmina.

Al loro interno viene riportato il nome di battesimo e l'eventuale soprannome-alias.

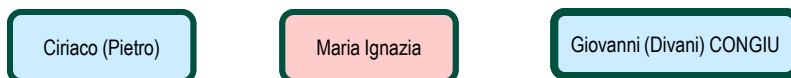

Ogni componente è individuato da un numero progressivo parlante che lo individua all'interno della famiglia, (vedi specialmente nella rappresentazione descrittiva), ad esempio :

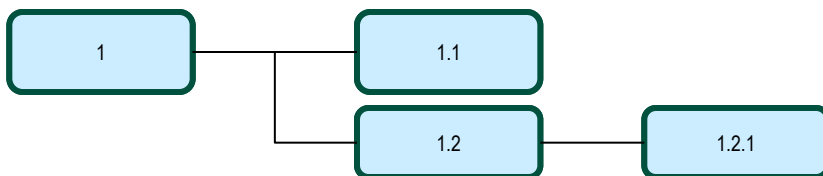

Il coniuge/consorte/compagno(a) eventuale viene indicato nel riquadro dopo il nome ed il cognome del discendente diretto, e dopo il carattere "&" (coniugato con).

Nel caso di una discendente femmina coniugata (nel riquadro rosa) la famiglia cambia nome, e viene indicato il nome del marito e il cognome in maiuscolo.



Se un consorte era precedentemente sposato l'eventuale figlio avuto con precedente consorte (non appartiene alla discendenza diretta) viene rappresentato con riquadro arancione..



1.2  
Famiglia del Secondo  
discendente maschio

SPIEGAZIONE ESEMPIO

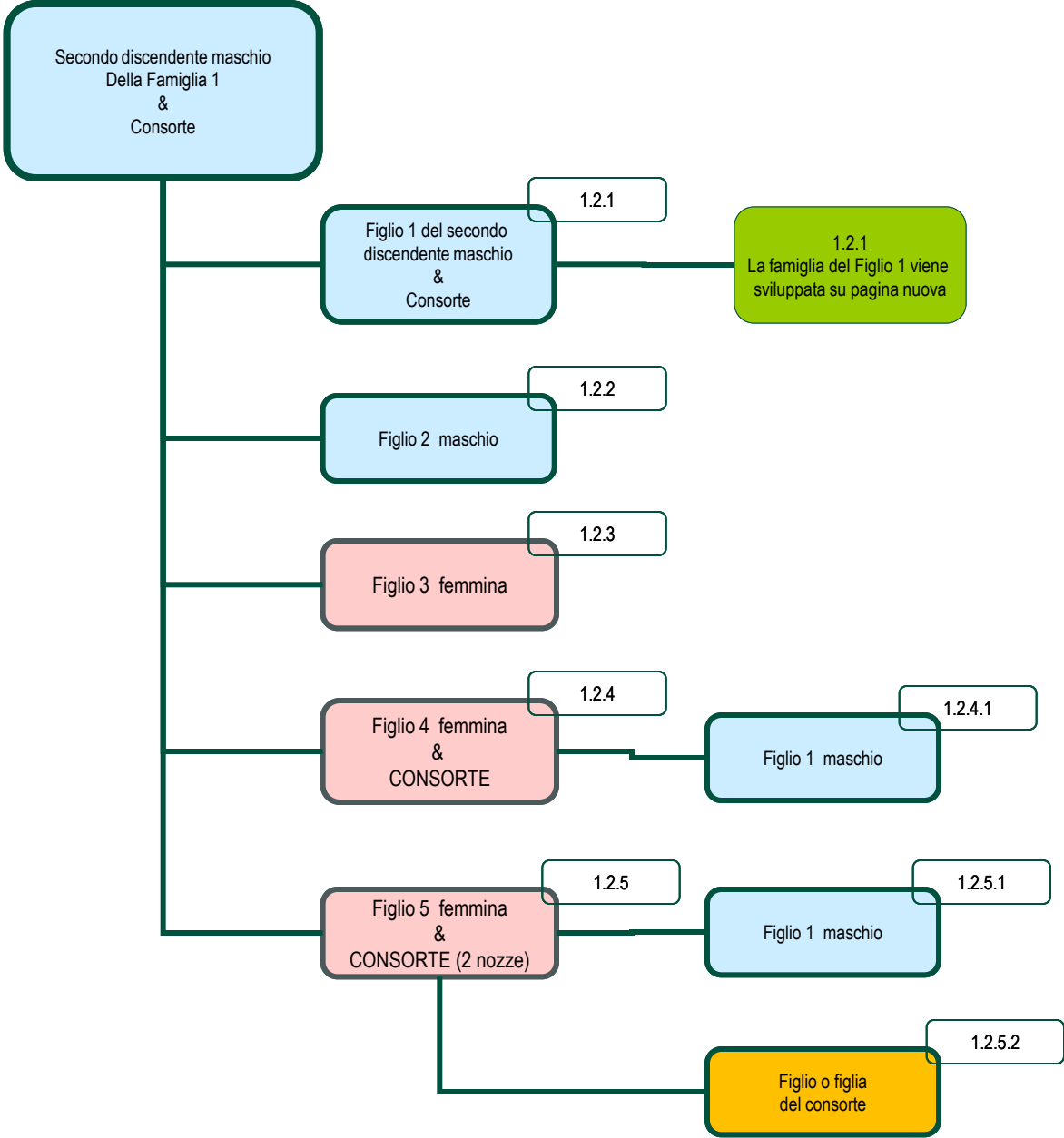



- **LEDDA**

- Decisamente sardo, dovrebbe derivare dal nome di una località che anticamente esisteva nella zona di Ozieri (SS) e che si chiamava appunto Ledda, secondo un'altra ipotesi potrebbe derivare dall'essere il capostipite nato nel mese di ottobre chiamato in sardo *ledàmine* per contrazione ledda.
- l'origine del cognome potrebbe essere riconducibile al nome di villaggio medioevale Ledda, Lella (Wolf 25, 57) dell'antica diocesi di Plaghe, citato in tutti i Contaghi, ma ormai scomparso, che naturalmente indica l'origine di individuo in quella località. Potrebbe anche avere origine da Aledda "aluccia, piccola ala". Geograficamente riscontrabile più frequentemente tra Oristano, Nuoro, Cuglieri e Bortigali
- (Prof. Massimo Pittau - "Dizionario dei Cognomi di Sardegna", Cagliari 2006, editrice "L'Unione Sarda")
- Antica famiglia di Bono, le cui notizie risalgono al secolo XVII. Nel 1632 ottenne il cavalierato ereditario, nel 1637 la nobiltà con un Giovanni, che nel 1643 fu ammesso allo stamento militare durante il parlamento Avellano. I suoi figli maschi gli perirono per cui lasciò il suo nome e l'eredità all'unica figlia che era sposata con un Filippo S ....

- ( HERALDRYS INSTITUTE OF ROME)



- In Italia : 1 913 persone hanno il [cognome Ledda](#) secondo i nostri dati  
Il [cognome Ledda](#) è il 1 228° più diffuso in Italia.

- **Dati per provincia**

- [Cagliari](#) [Ledda](#) è il 78° cognome 445 pers.
- [Sassari](#) [Ledda](#) è il 159° cognome 104 pers.
- [Genova](#) [Ledda](#) è il 967° cognome 89 pers.
- [Torino](#) [Ledda](#) è il 1 108° cognome 110 pers.
- [Roma](#) [Ledda](#) è il 1 465° cognome 207 pers.
- [Napoli](#) [Ledda](#) è il 1 744° cognome 93 pers.





## Genealogia Ledda



Giuseppe Luigi Ledda



Giovanna Onida







Giuseppe Luigi LEDDA  
&  
Giovanna Onida

Giovanni Nicola

Francesca

Antonio

Maria Luisa





# Genealogia Ledda

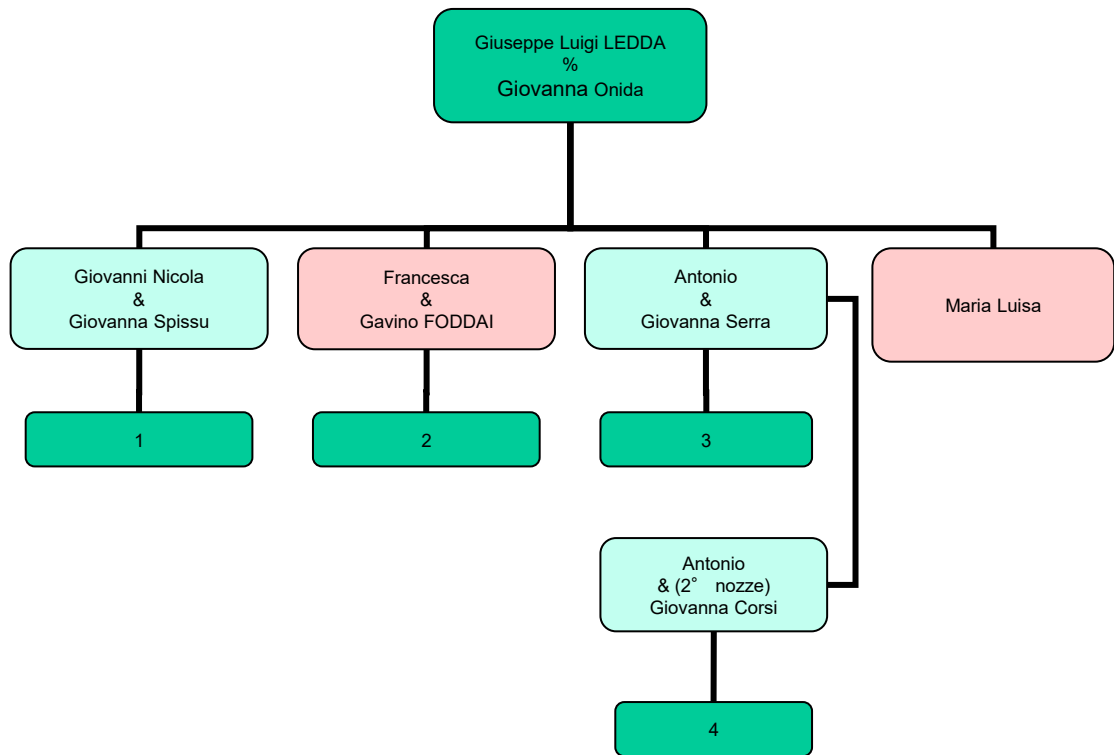



1

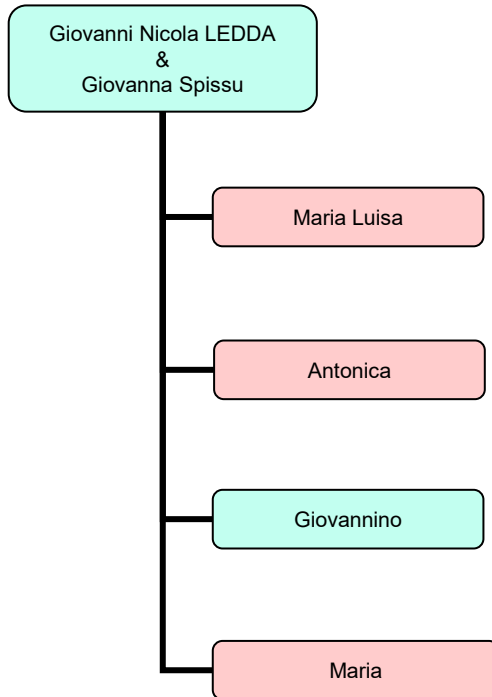

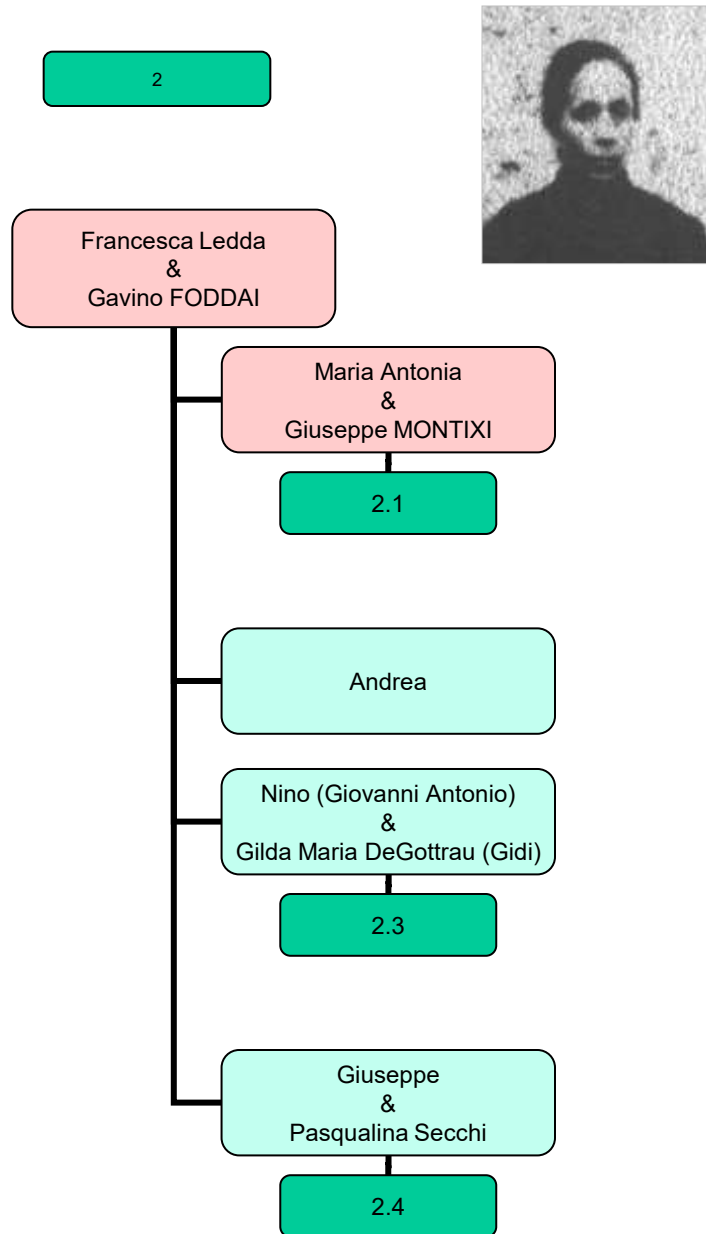

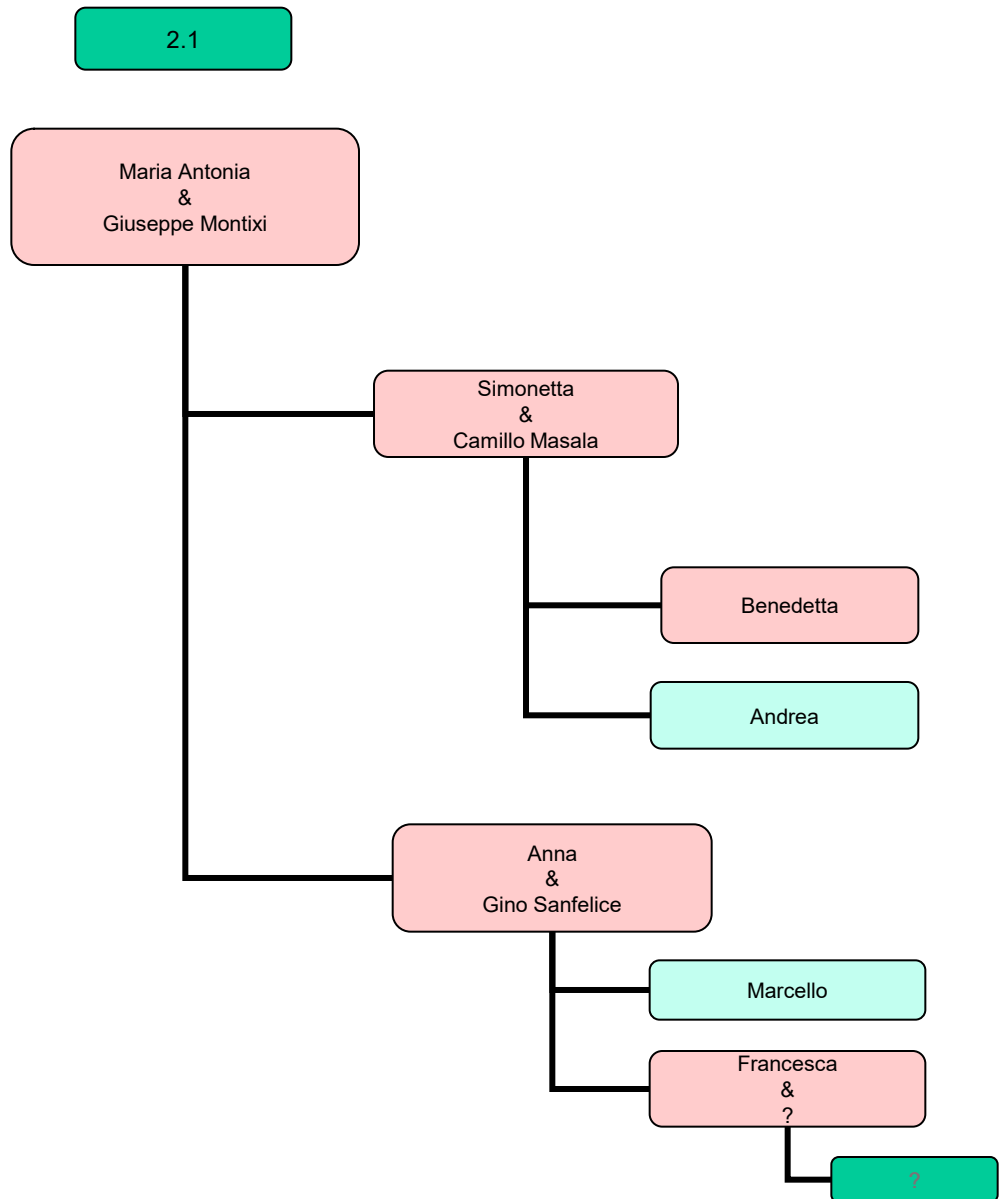

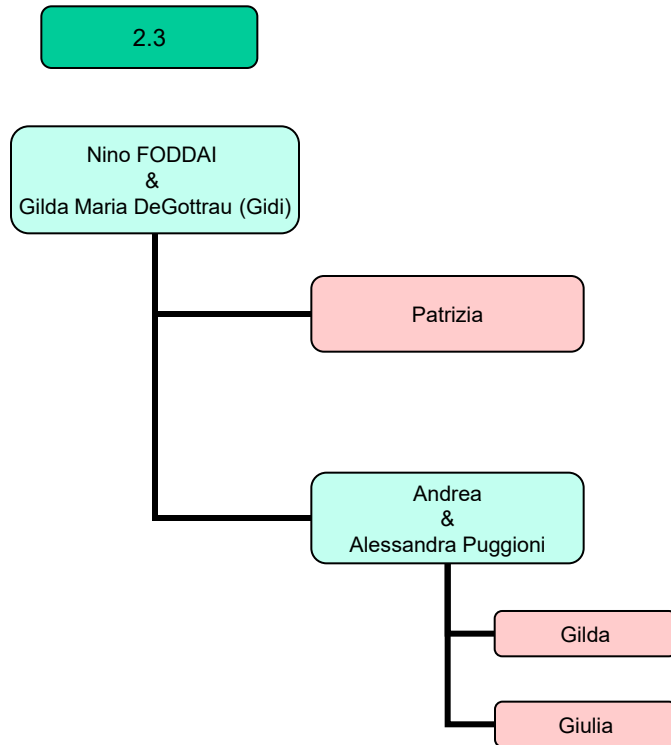

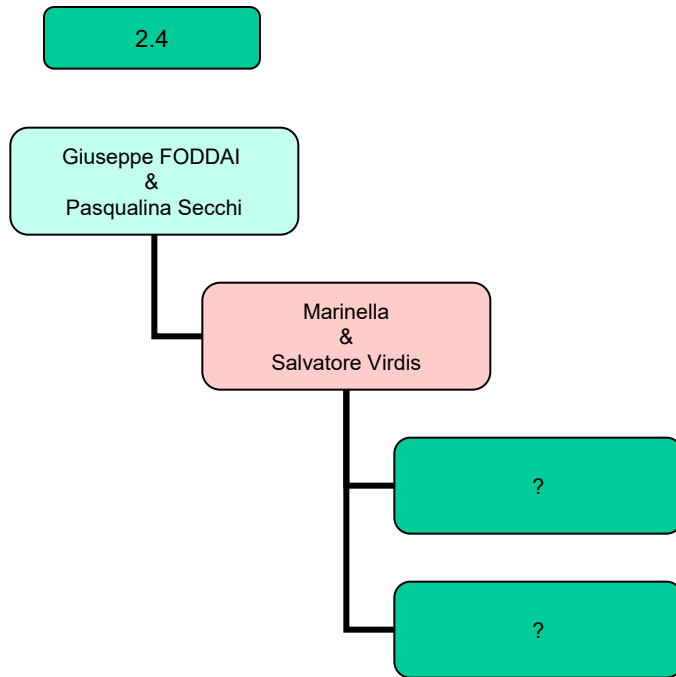







4  
Antonio LEDDA  
& (2^nozze)  
Giovanna CORSI

Discendenza di  
Antonio LEDDA  
&  
Giovanna SERRA



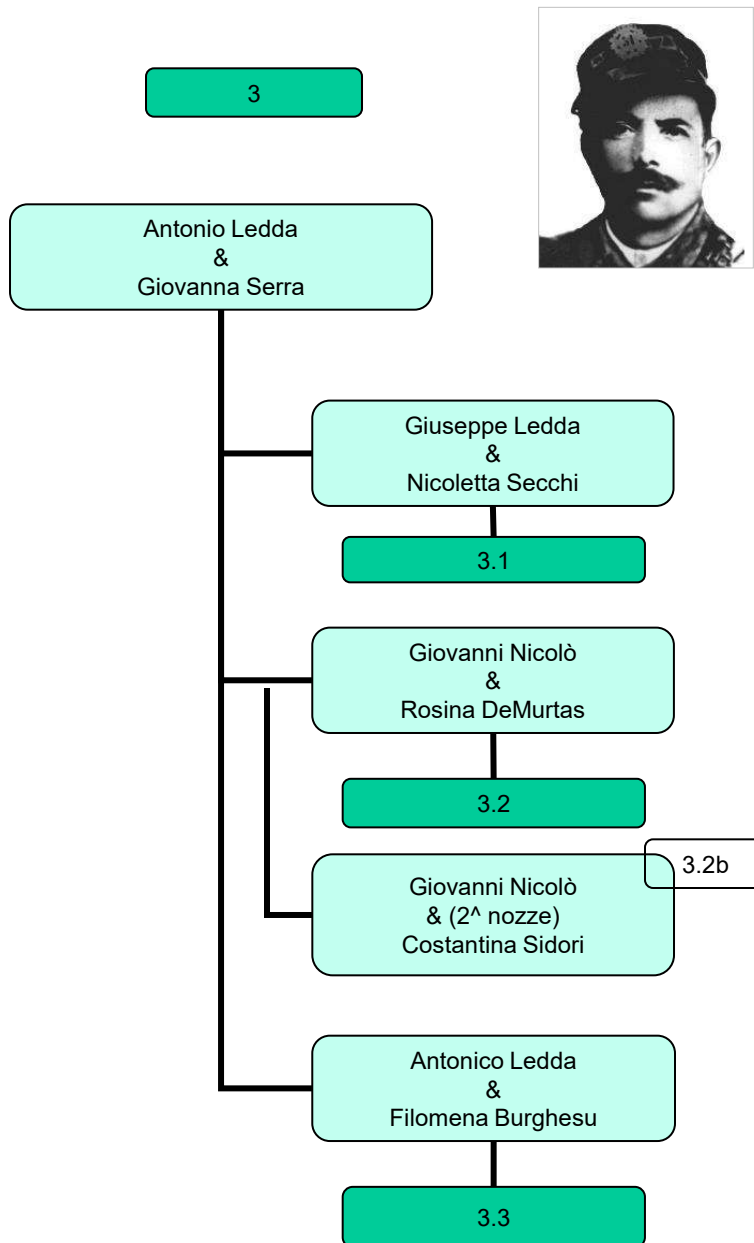



3.1

Giuseppe Ledda  
&  
Nicoletta Secchi



Nino  
&  
Maria Erre

Giuseppe  
&  
Laura Usai

Gabriele Mario

Luca  
&  
Gabriela Rizzu

Beatrice

Sara  
&  
Giancarlo Zilaghe

Giovanna

Paolo

Angelo  
&  
Giovanna Sanna

Roberto  
&  
Gabriela Russu

Elena

Guido  
&  
Ida Pulcina

Francesca

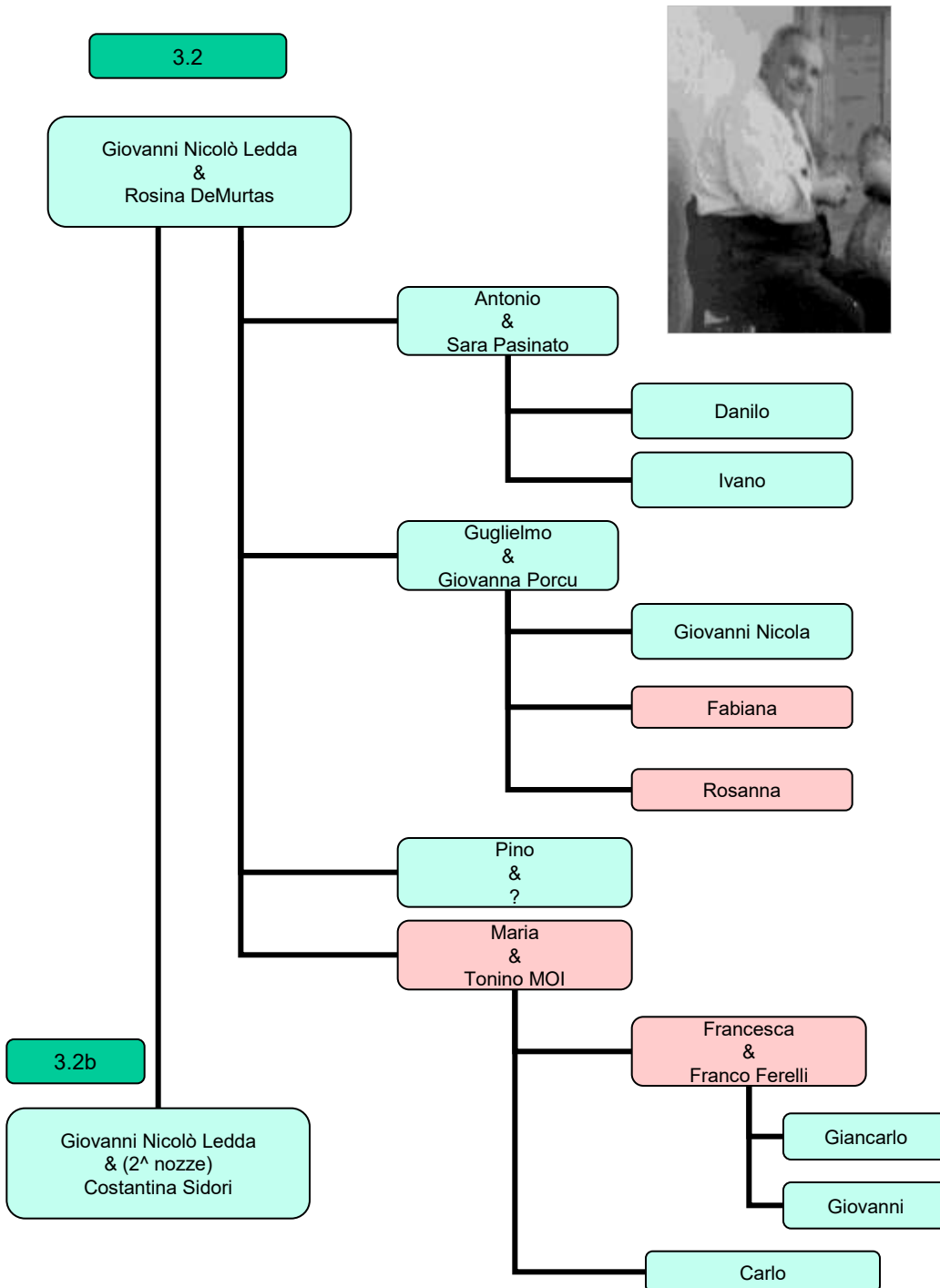

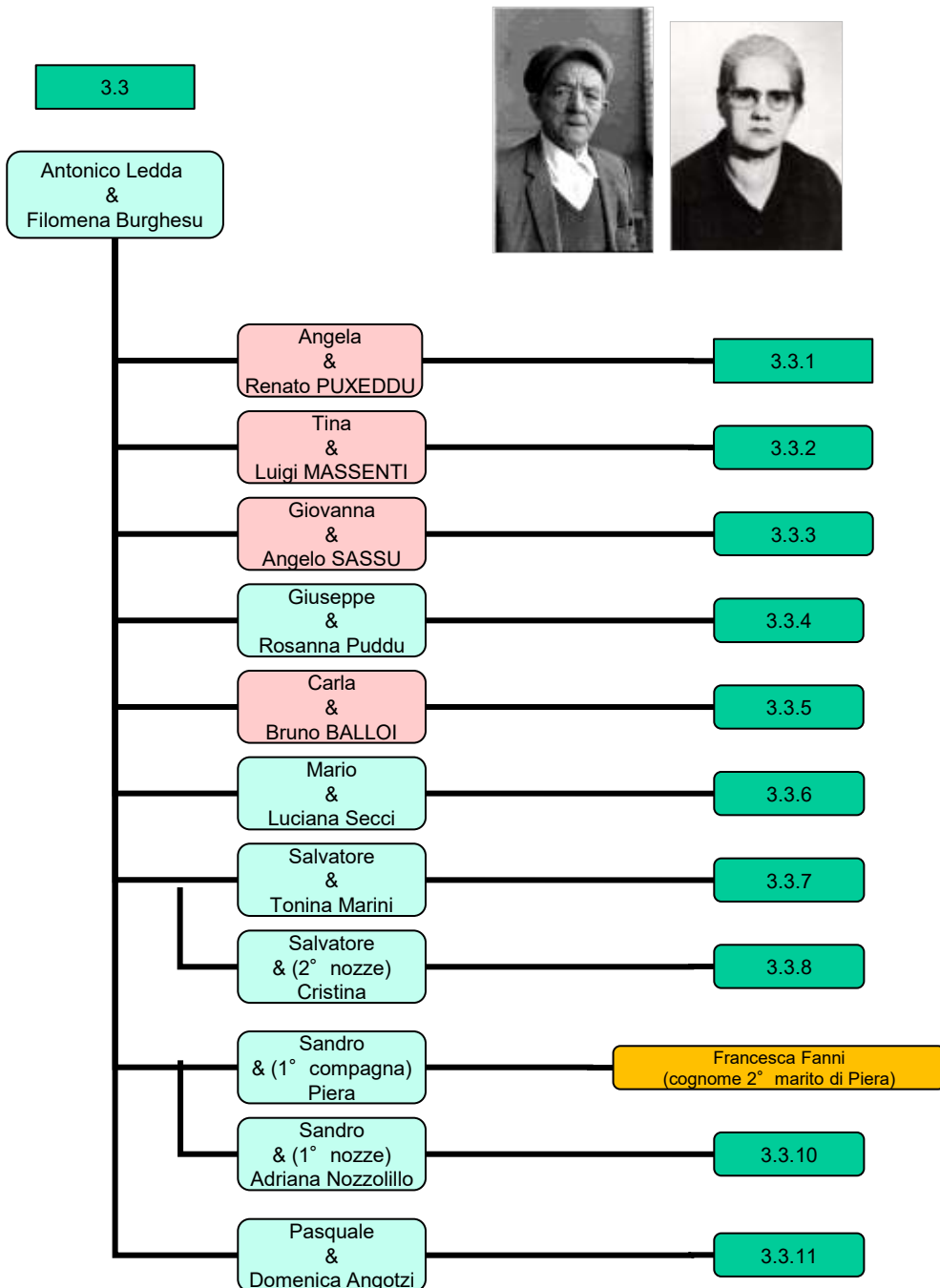



3.3.1

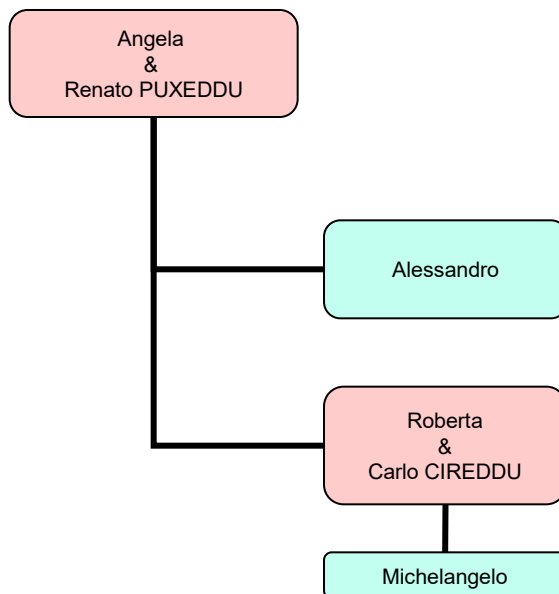



3.3.2

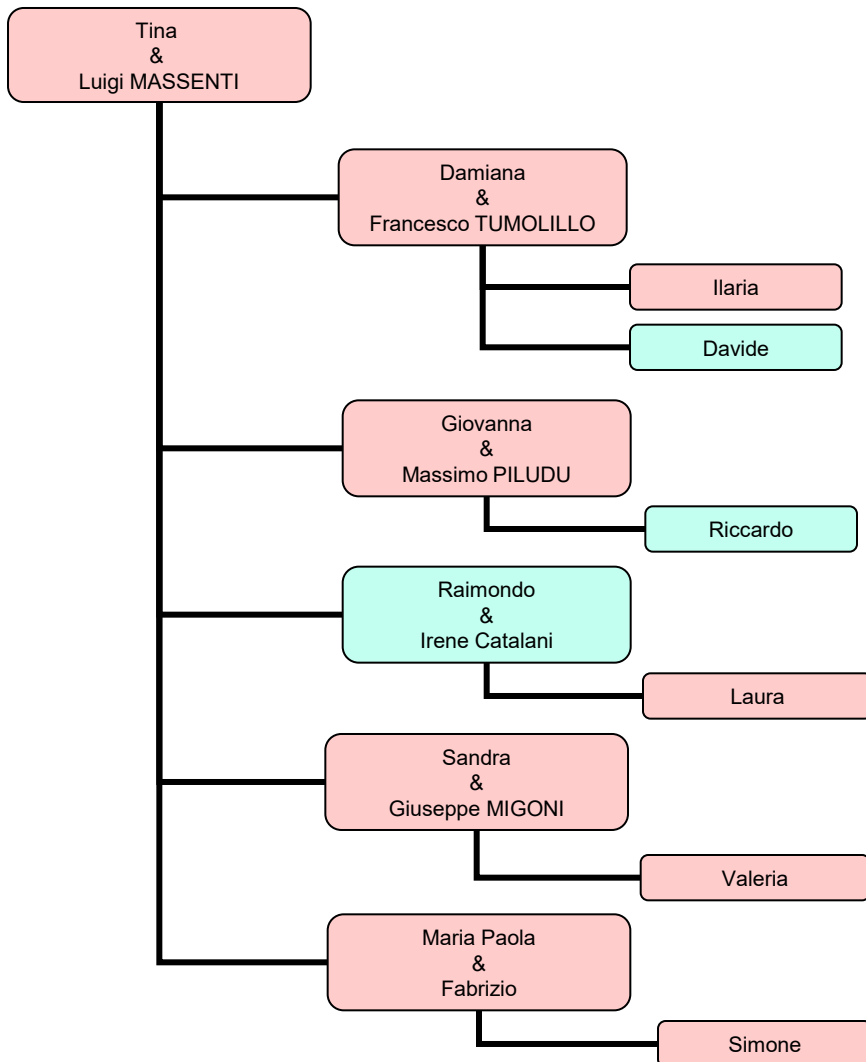

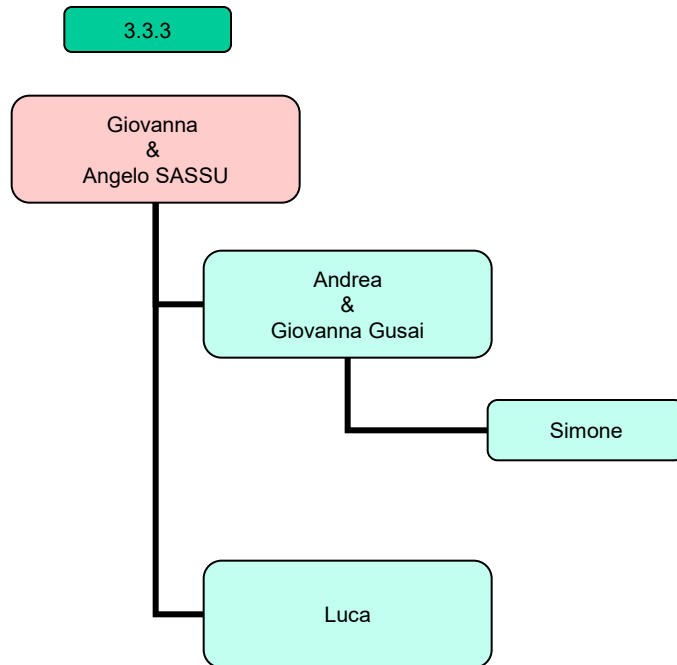





3.3.4

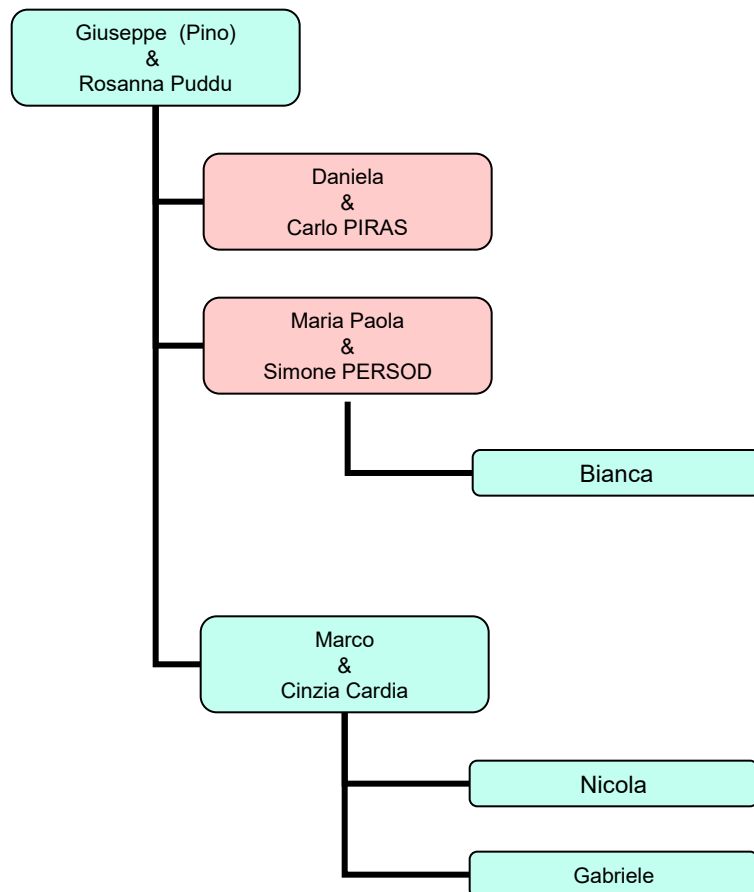



3.3.5

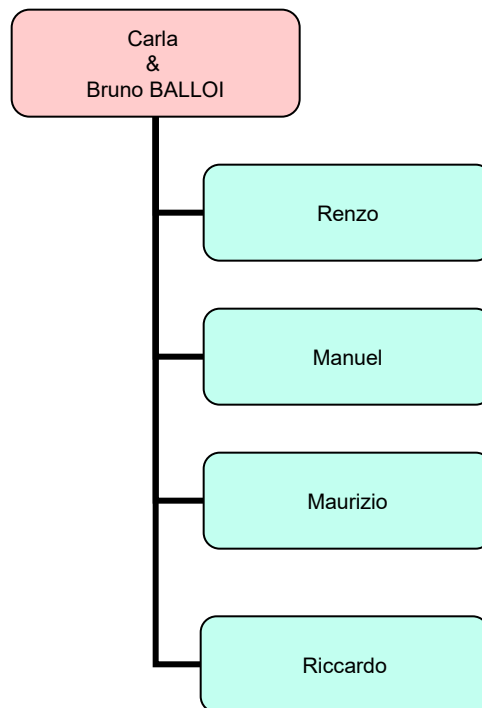

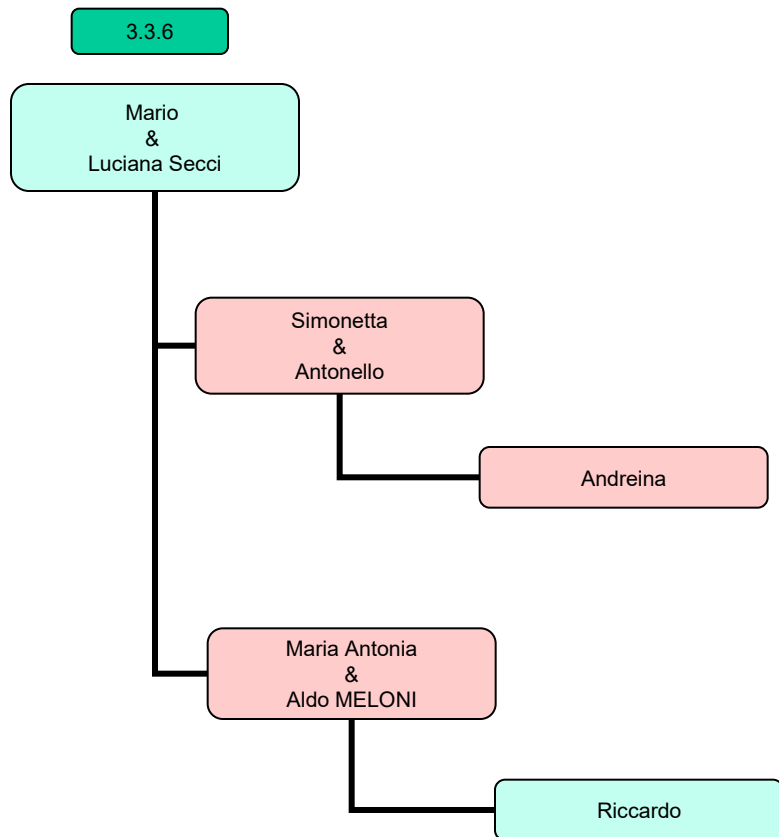



3.3.7

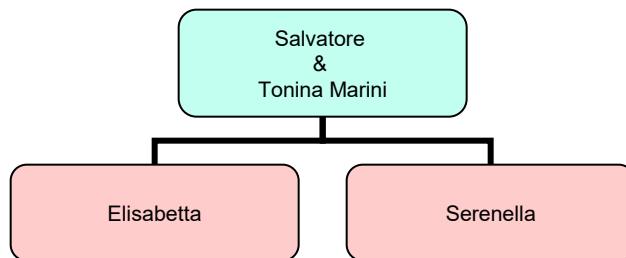

3.3.8

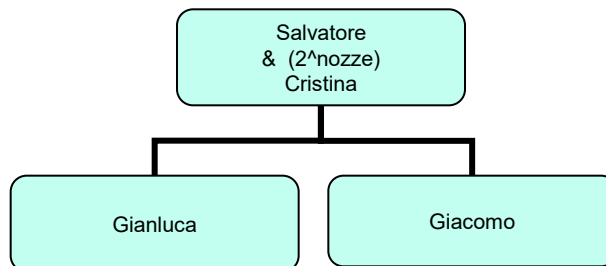

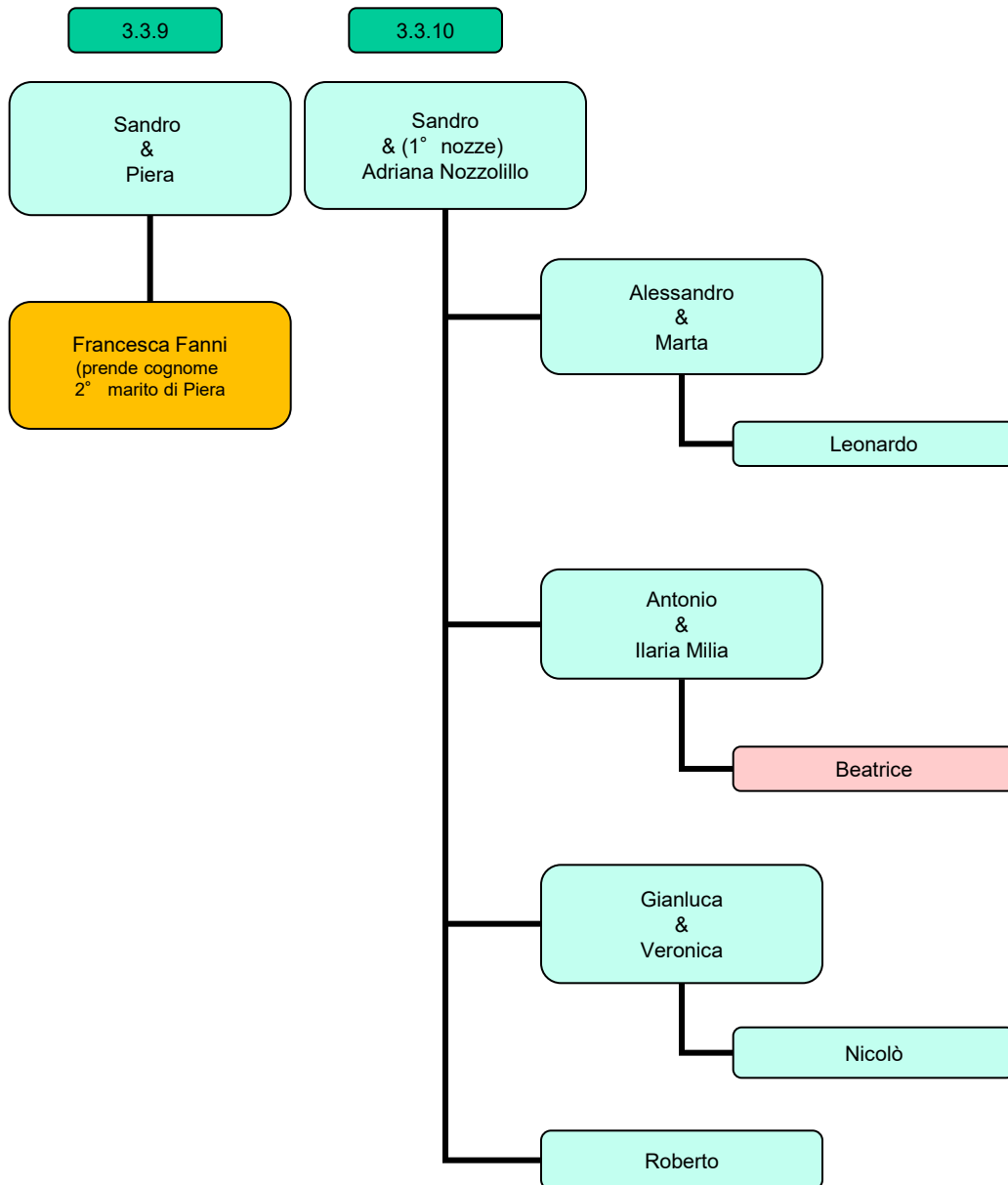

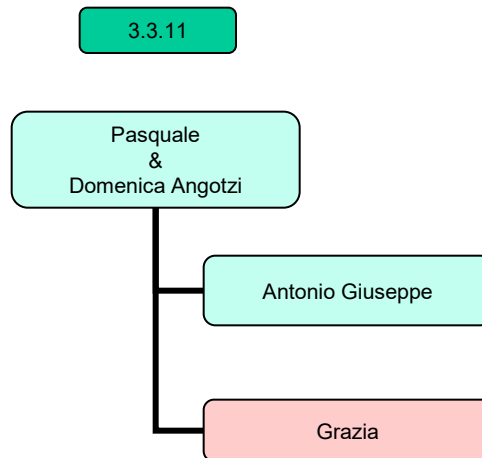



4  
Antonio LEDDA  
& (2<sup>a</sup>nozze)  
Giovanna CORSI

4

Discendenza di  
Giovanna CORSI  
seconda moglie di  
Antonio **LEDDA**





## Discendenza di Giovanna CORSI

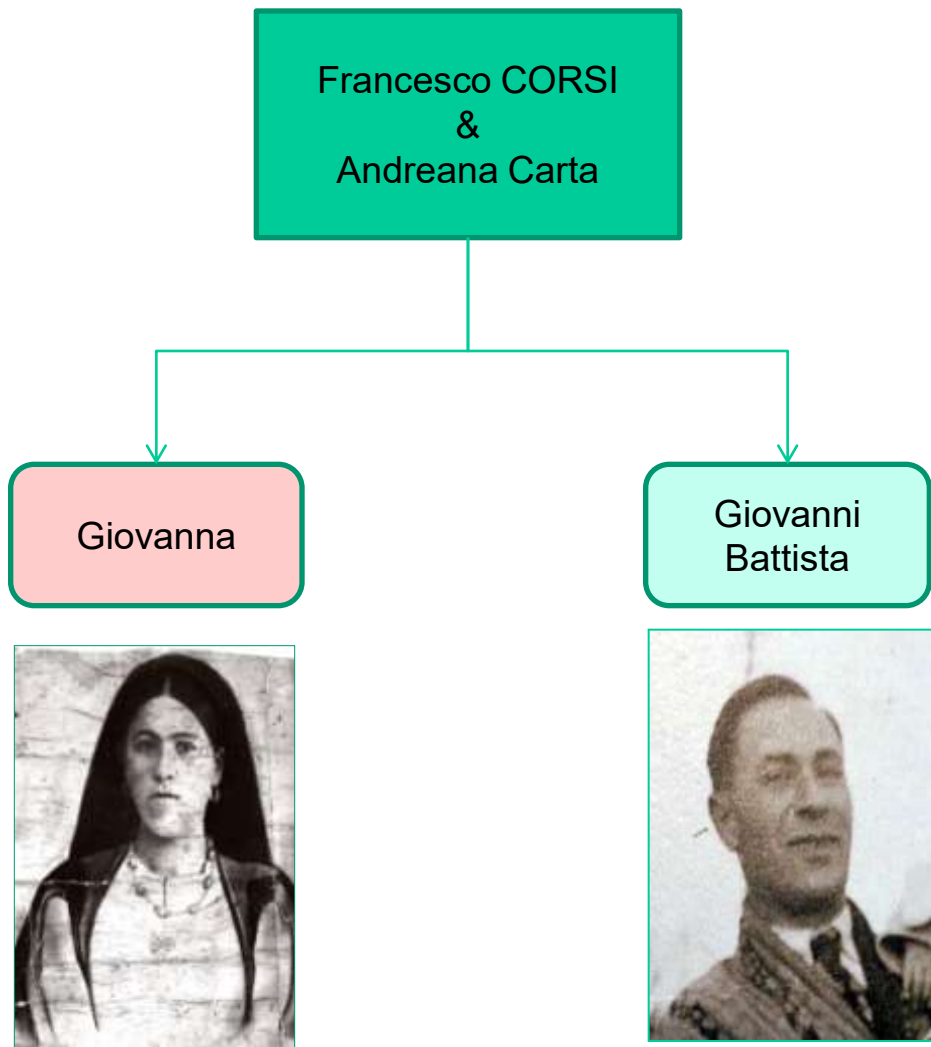



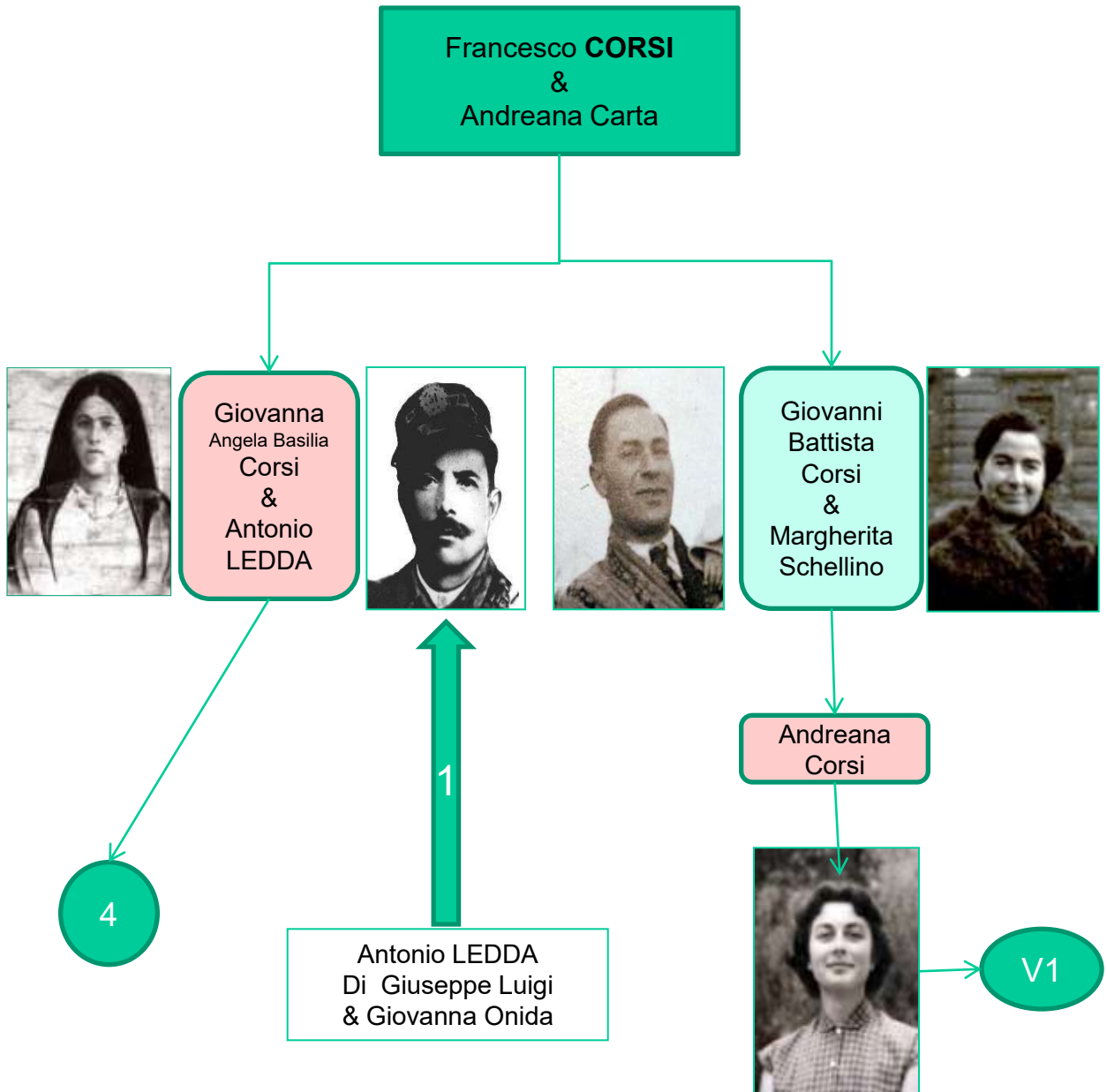



V1 - Giovanni Battista CORSI  
& Margherita Schellino

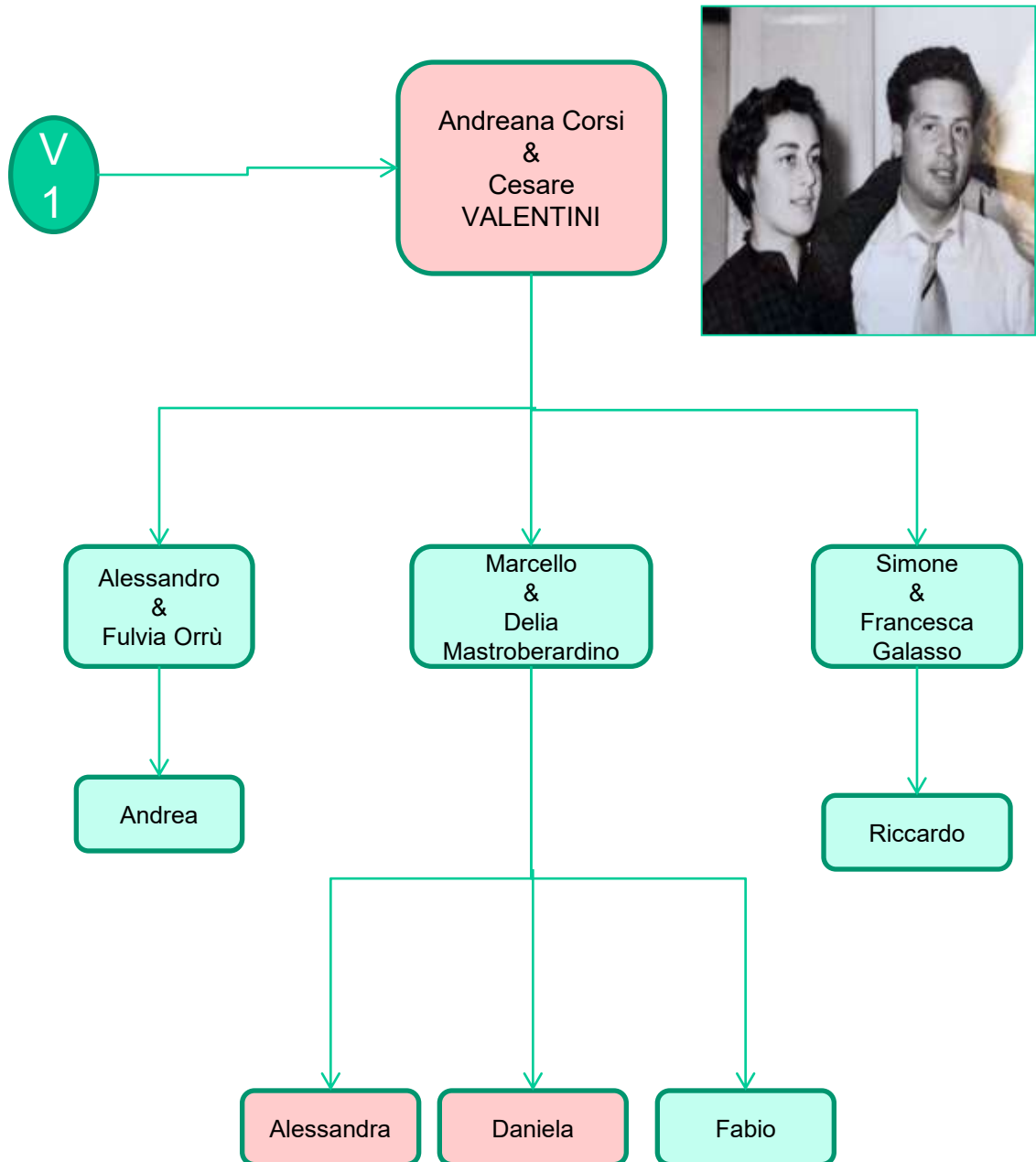

Discendenza di  
Antonio LEDDA  
&  
Giovanna CORSI



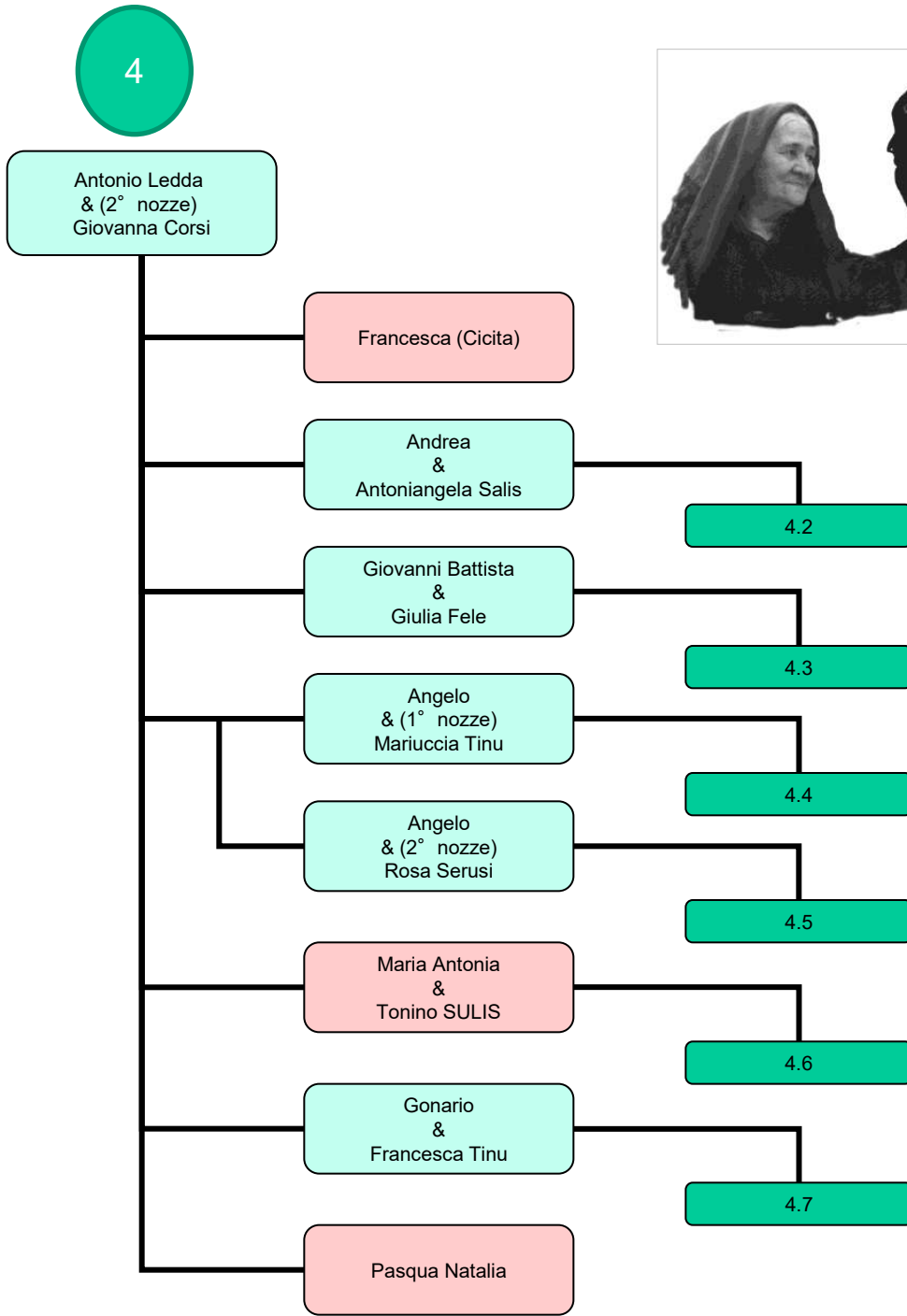

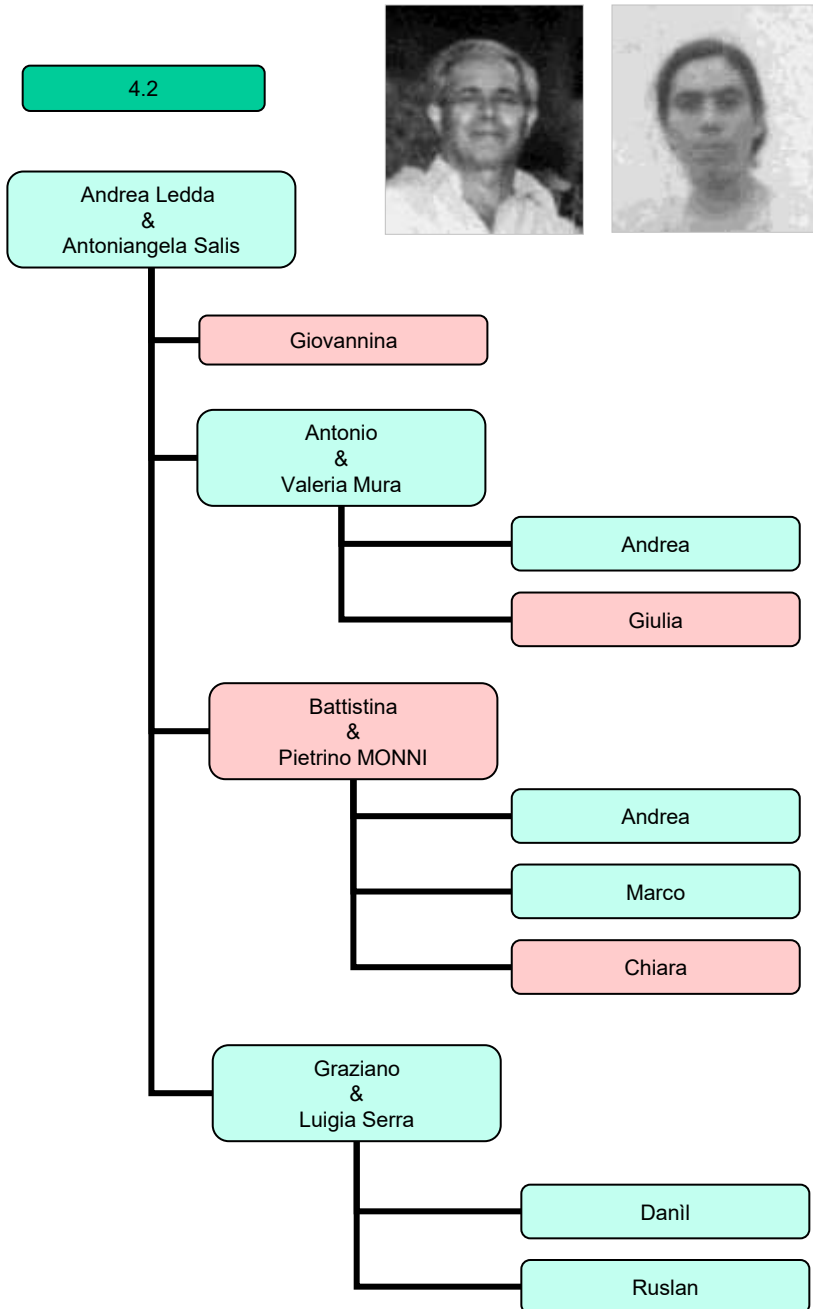

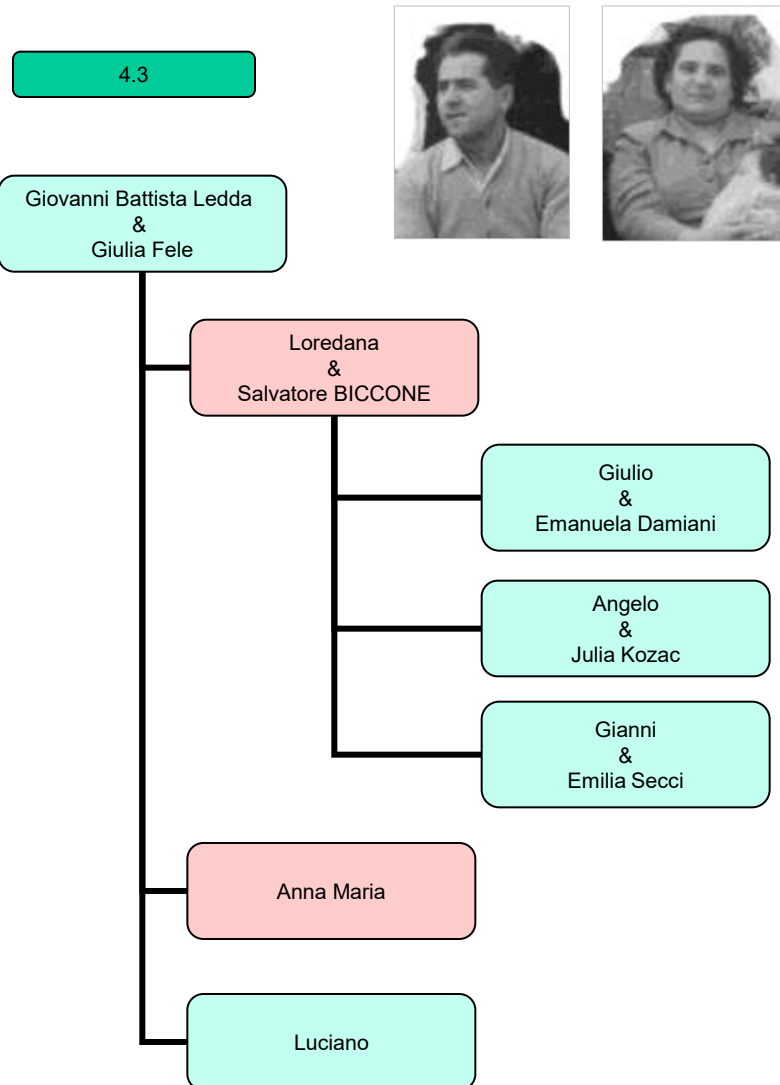

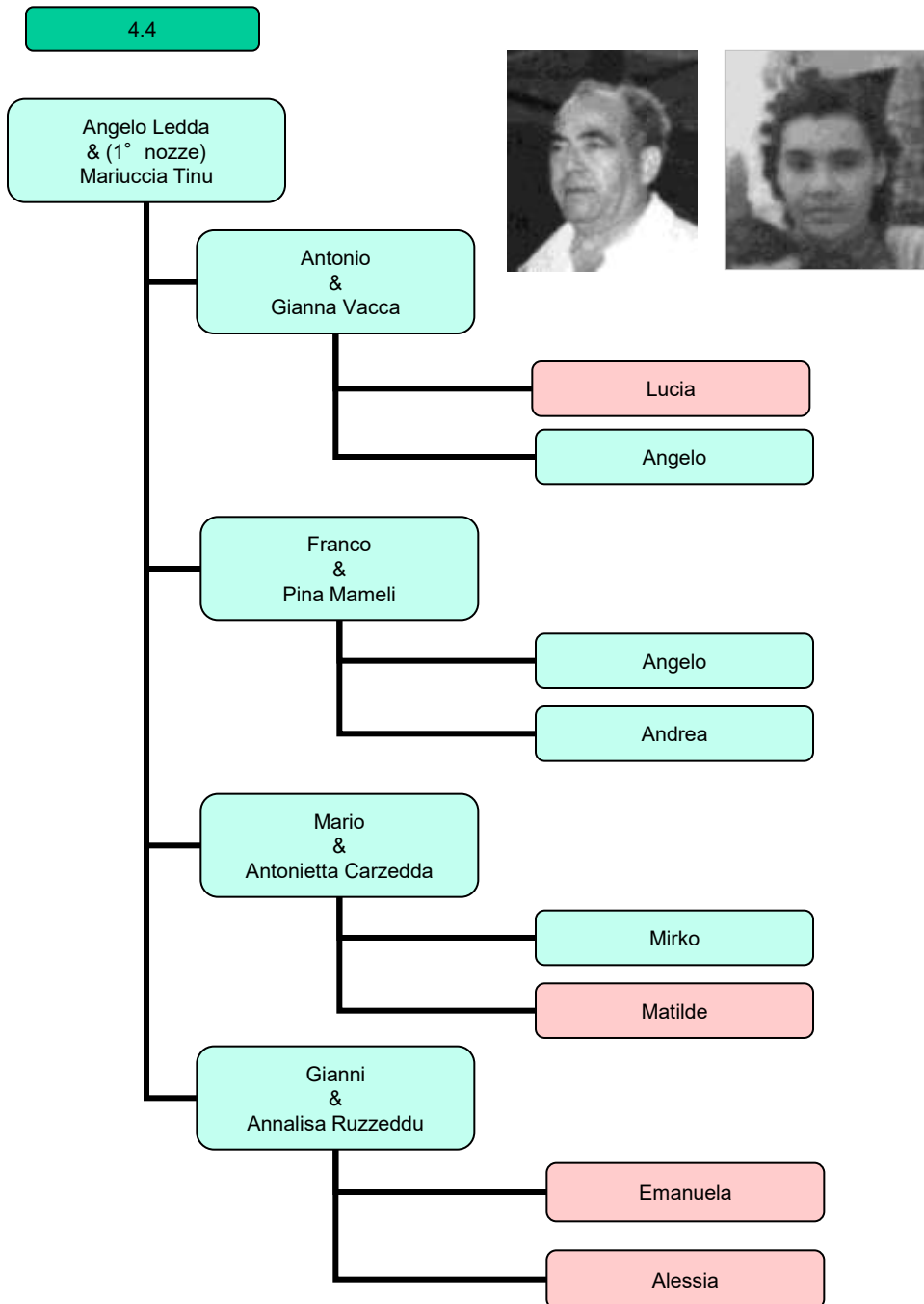

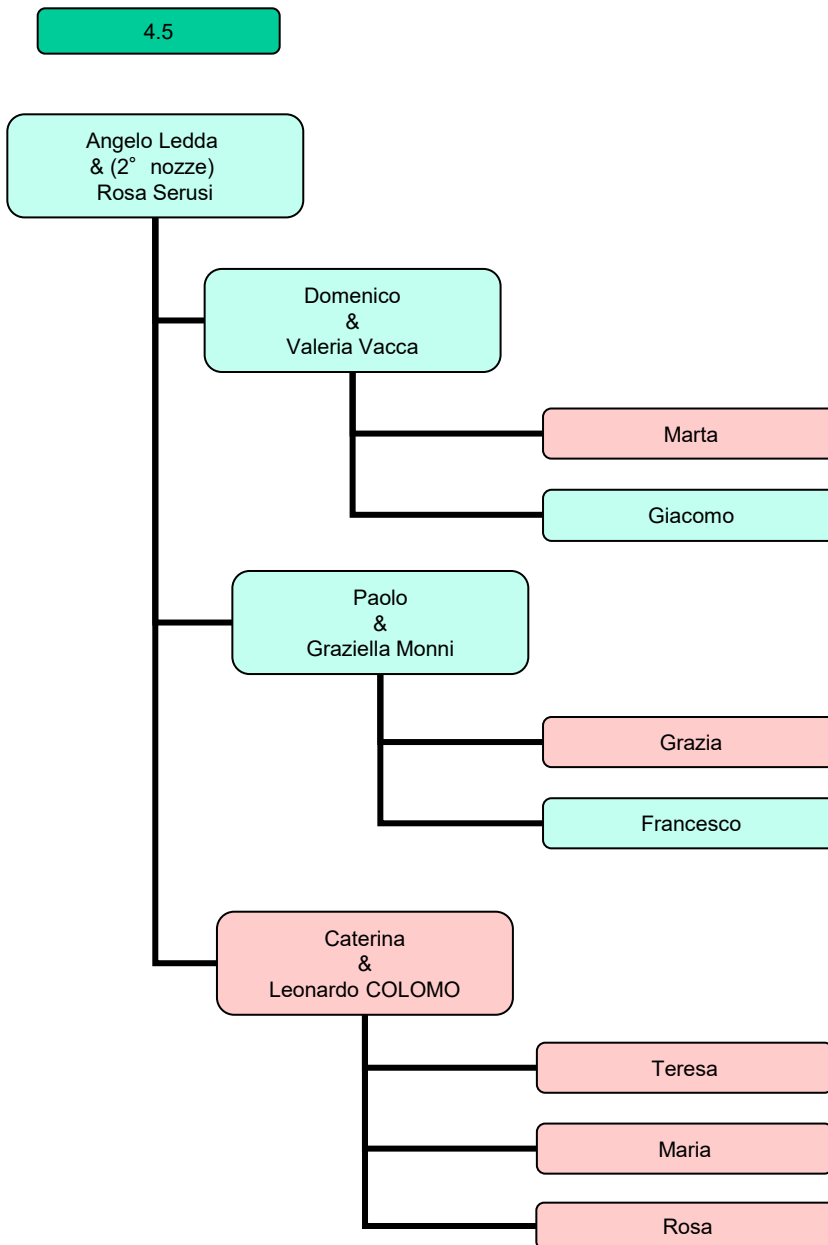



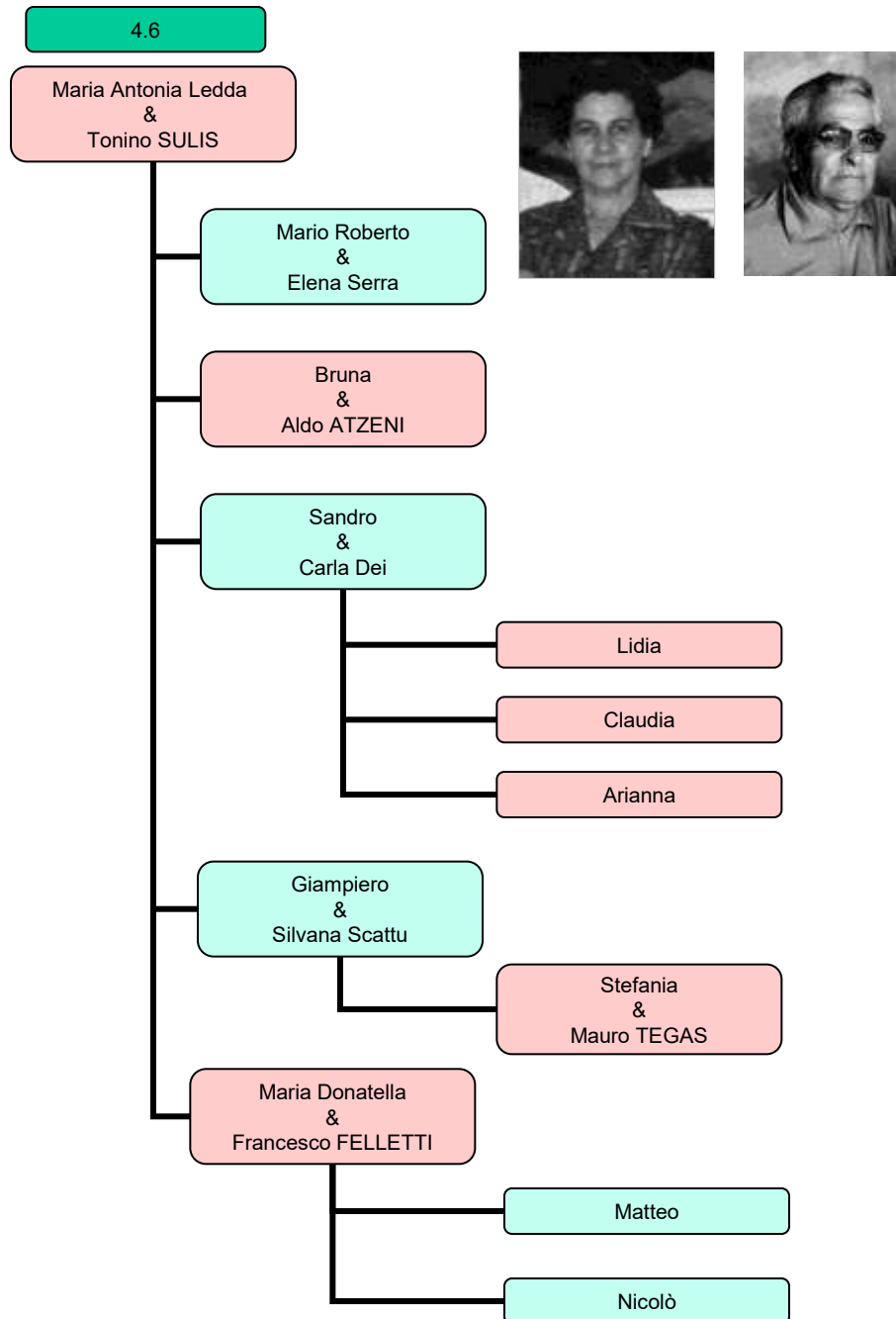

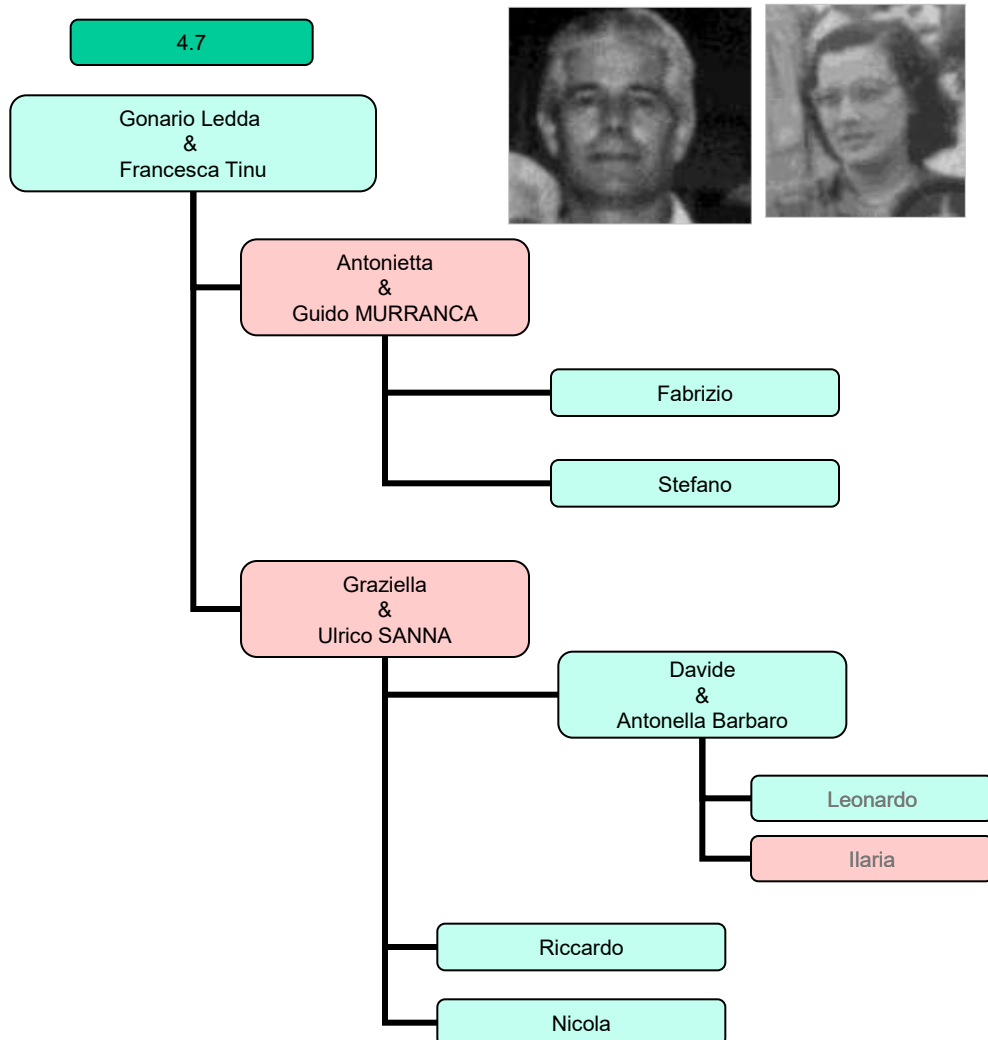



# IMMAGINI



- Antonio LEDDA                      Giave    26-07-1872    05-04-1924
- Giovanna Serra                      20-02-1908    ?
  
- Antonio LEDDA & Giovanna Serra                      Sposati il    ?
- Figli:
  - Giuseppe Luigi    Giave    10-12-1899    ?
  - Antonico            Giave    19-12-1905    22-08-1990
  - Giovanni Nicolò    Giave    15-09-1909    ?
  
- Giovanna Corsi                      Oliena    27-02-1890    18-06-1970
- Antonio LEDDA & Giovanna Corsi                      Sposati il    22-01-1913
- Figli:
  - Francesca            Oliena    24-05-1914    26-03-1988
  - Andrea                Oliena    05-05-1916    11-08-1991
  - Giovanni Battista    Oliena    28-06-1918    06-12-2003
  - Pasqua Natalia      Oliena    25-12-1919    12-04-2012
  - Angelo                Oliena    20-02-1921    17-04-1978
  - Maria Antonia        Oliena    23-05-1922
  - Gonario                Oliena    22-10-1923



Da Sin: Antonico Ledda, Giuseppe Luigi Ledda, Maria Luisa Ledda





•Da sin.in alto:  
Maria Cosima (cameriera),  
Maria Luisa Ledda,  
Cicita Ledda Foddai,  
Cameriera,  
Maria Luisa Ledda (figlia di Giovanni Nicolò)

Da sin in basso:  
Andrea Foddai, Maria Ledda, Mamma Giovanna Onida, Pino Foddai, Nino Foddai

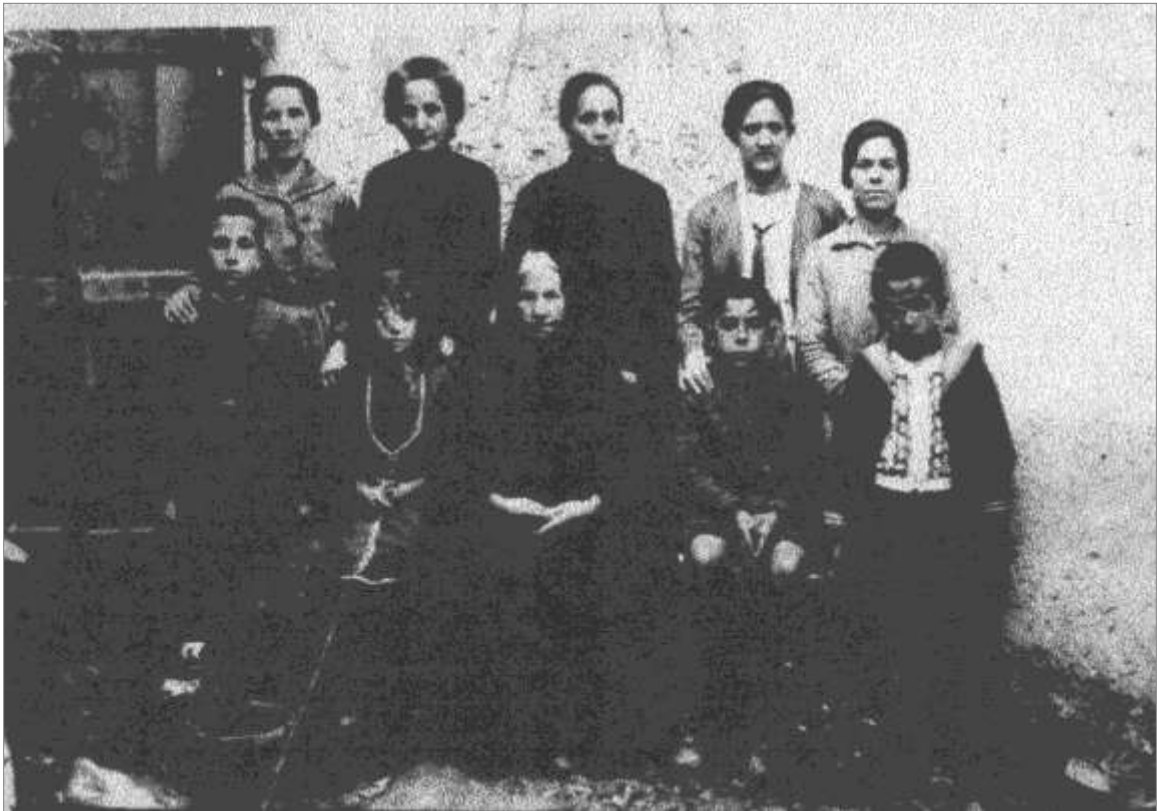



Giovanna Corsi





Giovanna Corsi & Antonio Ledda







Fratelli Ledda:  
Giovanni Nicola, Giuseppe, Antonico





Fratelli Ledda:

(Da sin) Andrea, Pasqua Natalia, Cicita, Gonario, Maria, Giovanni Battista, Angelo





Da sin.in alto:  
Graziella Ledda, Loredana Ledda, Andrea Ledda, Antoniangela Salis-Ledda, Antonietta e Gonario Ledda  
Seconda fila: Francesca Tinu-Ledda, Francesca (Cicita) Ledda  
Terza fila: Pasqua Natalia Ledda, Mariuccia Tinu-Ledda con Antonio, Cecilia Canudu, Giovanna Corsi-  
Ledda, Giulia Fele-Ledda con Annamaria  
Al centro in primo piano: Giovanni Battista Ledda  
In basso a sinistra: Lussoria





Foto grande (da sin.):  
Giovanna Corsi-Ledda,  
Giovannina con Cicita Ledda,  
Andrea Ledda, Antoniangela  
Salis-Ledda, Vanna Ledda;  
(seduti) Mariuccia Tinu-Ledda,  
Tonino Ledda

Foto Piccola: Giovanni Nicolò  
Ledda e Giulia Fele-Ledda





Da sin.alto: Cicita Ledda, Giulia Fele-Ledda, Natalia Ledda  
Seduti: Salvatore Calamida, Pasqualina Fele, Efisia Calamida-Fele, Giovanna Corsi-Ledda  
In basso: Andrea Ledda con Loredana, Giovanni B. Ledda



Foto colori: Famiglia Sulis  
Da sin: Donatella, Sandro,  
Maria Ledda-Sulis, Brunella  
Roberto, Giampiero



Gonario Ledda e Francesca Tinu-Ledda  
60 anni dalle Nozze - ottobre 1946-2006





Giovanni Battista Corsi & Margherita Schellino





Giovanni Battista Corsi con Andreana





Andreana Corsi

Aggiornamento 2020



Matrimonio di  
Tonio Ledda e Sara  
Pasinato



Cicita Ledda e Rosa Serusi-  
Ledda con Gionanna  
(nannedda) Corsi-Ledda,  
Mario, Franco e Gianni



Maria Ledda e Giovanna (Nanneda) Corsi-Ledda



Tonino Sulis

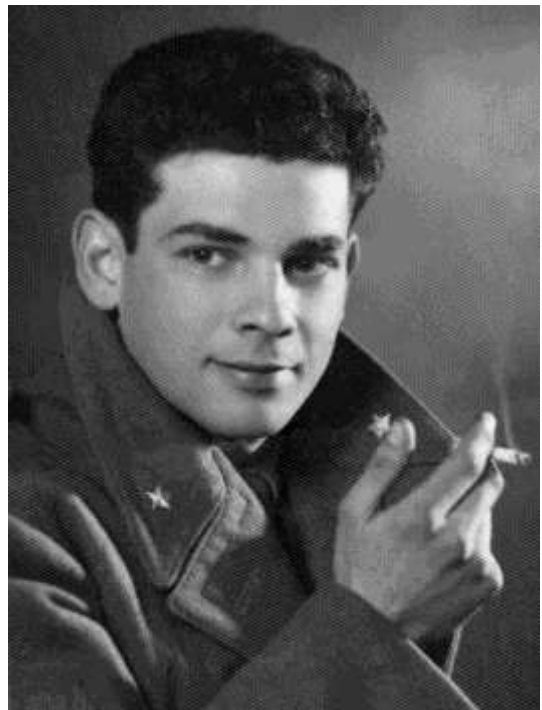

Angelo Sassu